



# EL BINOMIO AGUA Y ENERGÍA EN LA INDUSTRIA

**REWAGEN: Electrochemical Water treatment  
system in the dairy industry with hydroGEN  
REcovery and electricity production**

Anna Serra Clusellas, LEITAT TECHNOLOGICAL CENTER

26 noviembre 2014

**CONAMA2014**



REWAGEN: Electrochemical WATER treatment system in the dairy industry with hydroGEN REcovery and electricity production

## Proyecto REWAGEN

**LEITAT** | Technological  
Center  
managing your technologies member of **TECNIO**  
Do well. Do something.

# 01 Proyecto REWAGEN



CONAMA2014



REWAGEN: Electrochemical WATER treatment system in the dairy industry with hydroGEN REcovery and electricity production

# 01. Proyecto REWAGEN



## → CONSORCIO

ENV.2011.3.1.9-1 Eco-innovation!

Presupuesto: 6,1 M€

EC Contribution: 4,6 M€

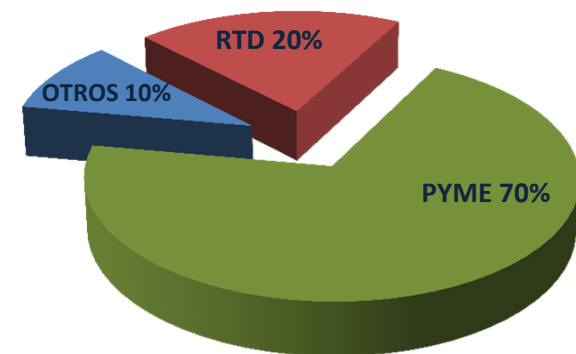



REWAGEN: Electrochemical WATER treatment system in the dairy industry with hydroGEN REcovery and electricity production

## 01. Proyecto REWAGEN

**LEITAT** | Technological Center  
managing your technologies member of **TECNIO**  
El més del comerç

→ **CONSORCIO**





# 01. Proyecto REWAGEN

## → ESTRATEGIA REWAGEN

- Tratamiento mediante tecnología electroquímica
- Ciclo del agua cerrado
- Valorización de H<sub>2</sub> residual
- Nuevo diseño de celda electroquímica: **binomio agua-energía**
- Minimización de residuos
- Demostración en planta piloto

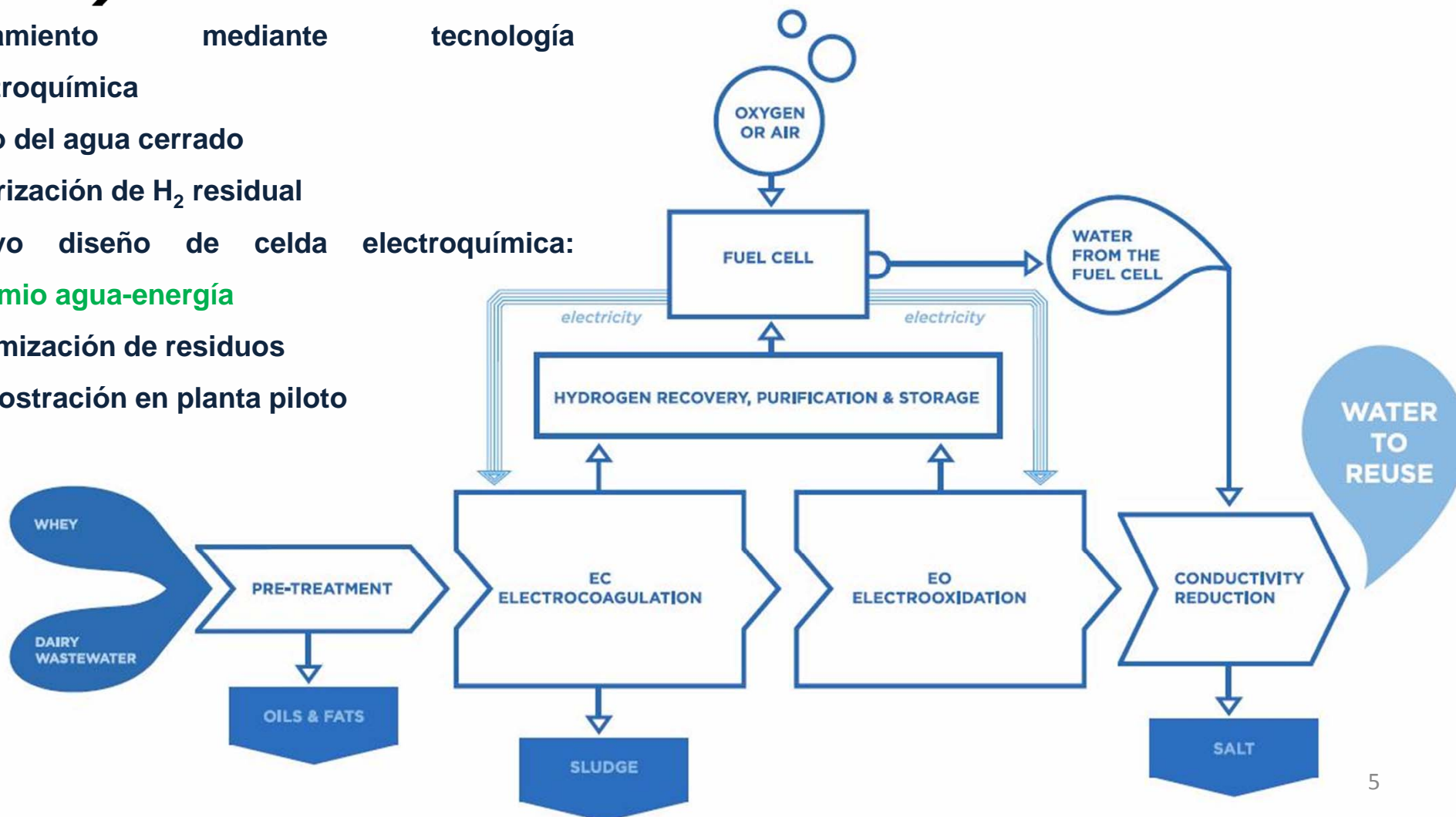





## 01. Proyecto REWAGEN

### → PROBLEMÁTICA

- **Sector alimentación –industria láctea**
- **Aguas residuales:** DQO, SS, fosfatos, turbidez, ...
  - Procesos de limpieza (equipos, instalaciones)
  - Acondicionamiento aguas pozo/red
  - Aguas sanitarias
  - ...
- **Suero de la producción de queso:** elevada conductividad, O&G emulsionado, elevada DQO, etc.
- **Variación en los ciclos productivos y procesos:** composición variable





REWAGEN: Electrochemical WATER treatment system in the dairy industry with hydroGEN REcovery and electricity production

## Proyecto REWAGEN

**LEITAT** | Technological  
Center  
managing your technologies member of **TECNIO**  
by work, for companies

# 02 Proceso de electrocoagulación (EC)

CONAMA2014



## 02. Proceso de electrocoagulación (EC)

### → CONCEPTO EC y OBJETIVOS

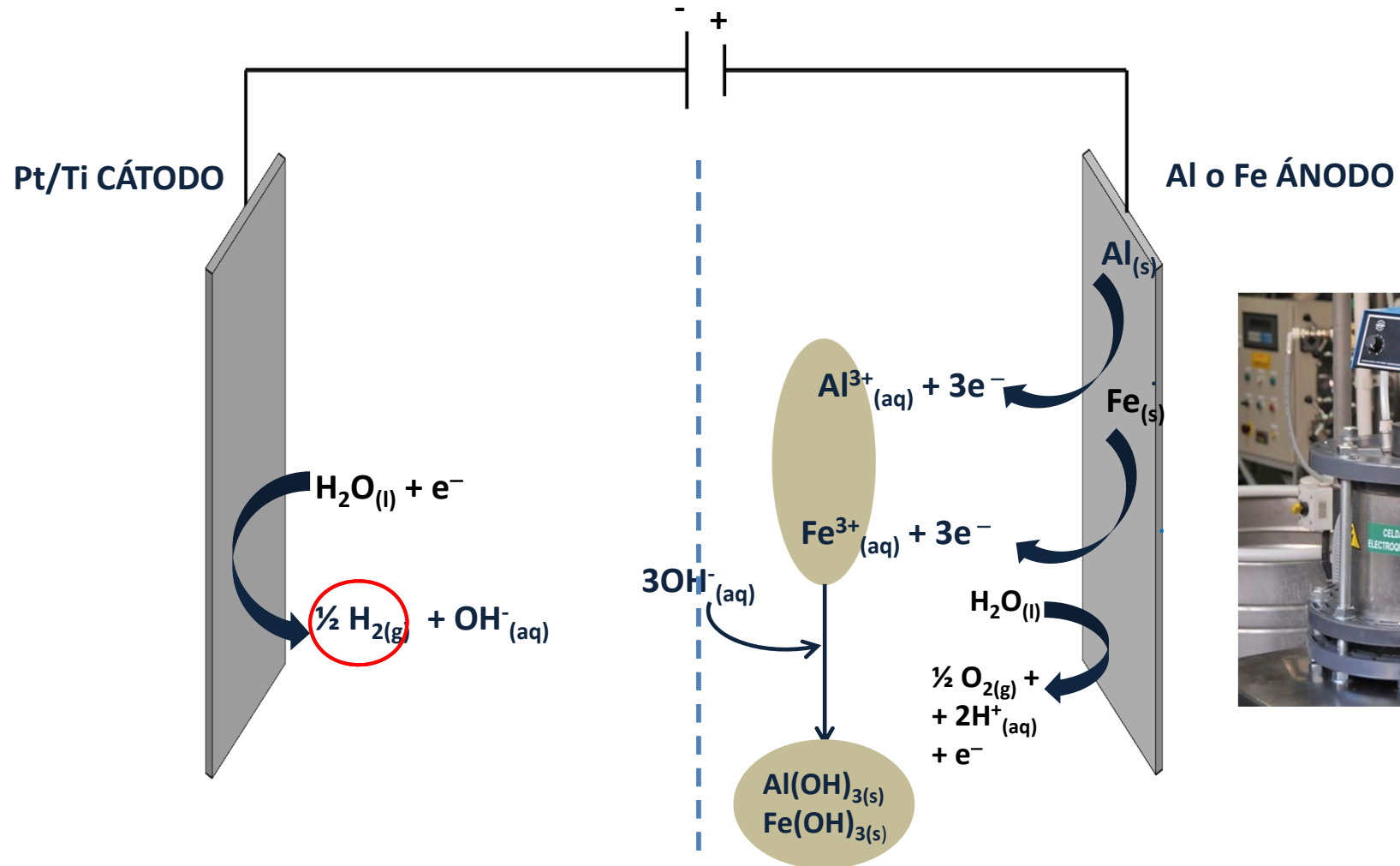





## 02. Proceso de electrocoagulación (EC)

### → NUEVO DISEÑO DE CELDA

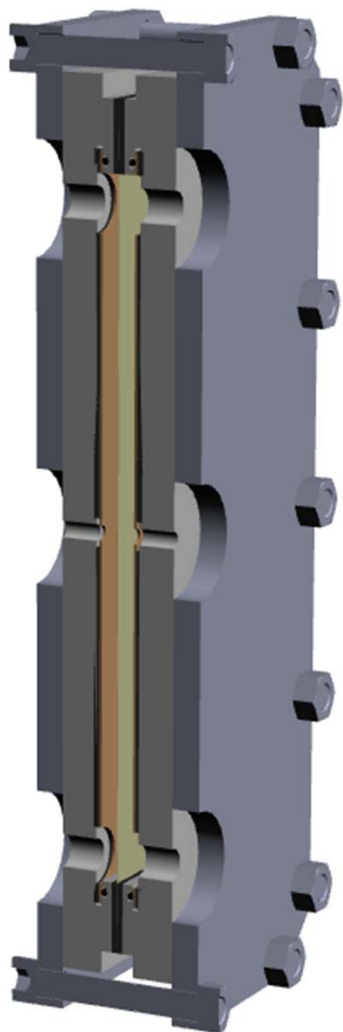

- **Celda bi-compartmental** (electrodos en compartimentos separados)
- Membrana porosa **de intercambio aniónico** (sin intercambio de gases)
- Recuperación del hidrógeno del compartimento del cátodo → **compartimento cerrado**
- Liberación de  $O_2$  y  $CO_2$  del compartimento anódico





## 02. Proceso de electrocoagulación (EC)

### → NUEVO DISEÑO DE CELDA

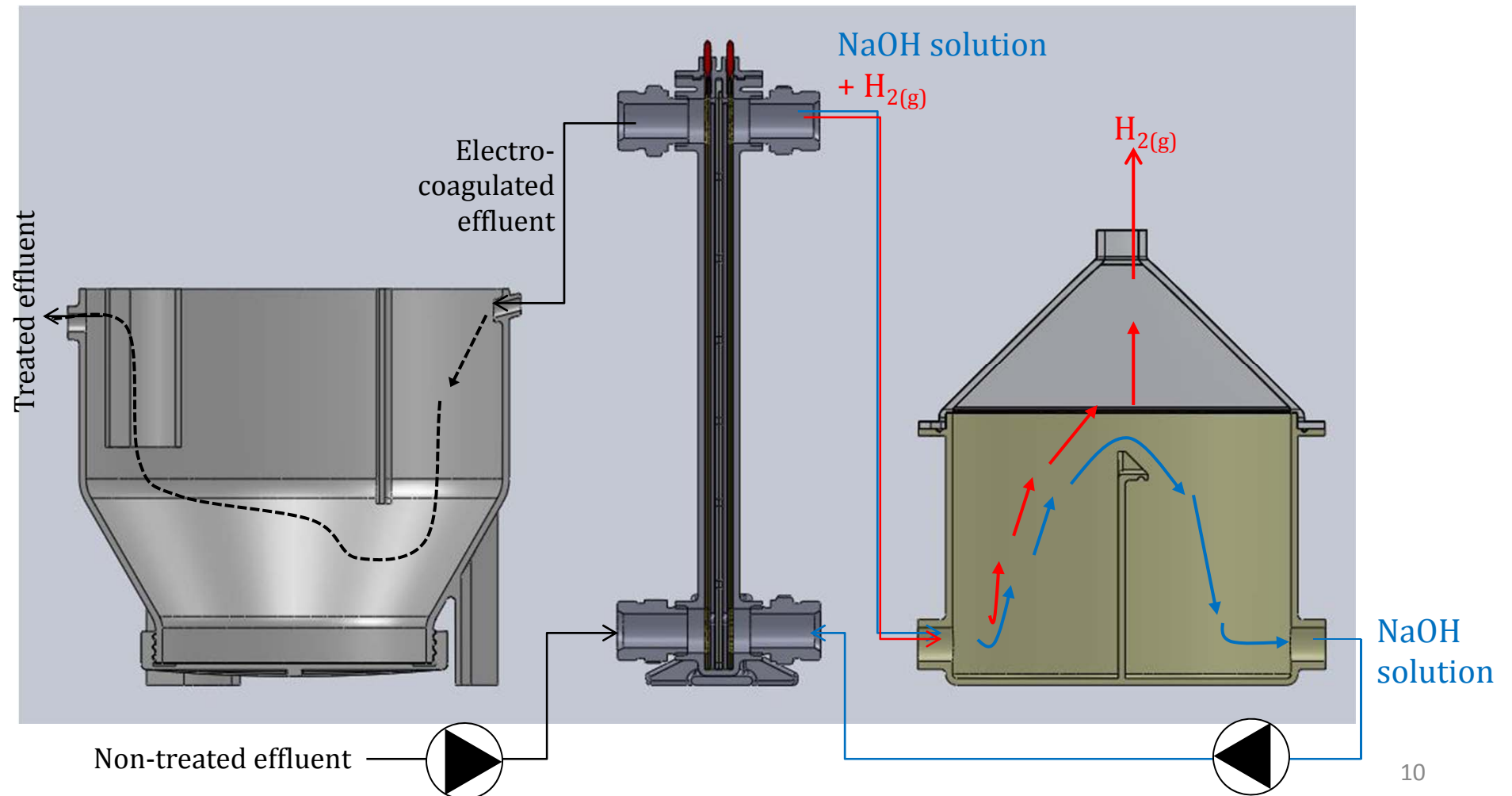



REWAGEN: Electrochemical WATER treatment system in the dairy industry with hydroGEN REcovery and electricity production

## 02. Proceso de electrocoagulación (EC)

**LEITAT** | Technological Center  
managing your technologies member of **TECNIO**  
By with the companies

### → NUEVO DISEÑO DE CELDA





## 02. Proceso de electrocoagulación (EC)

### → CARACTERIZACIÓN DEL EFLUENTE DE LA INDUSTRIA LÁCTICA

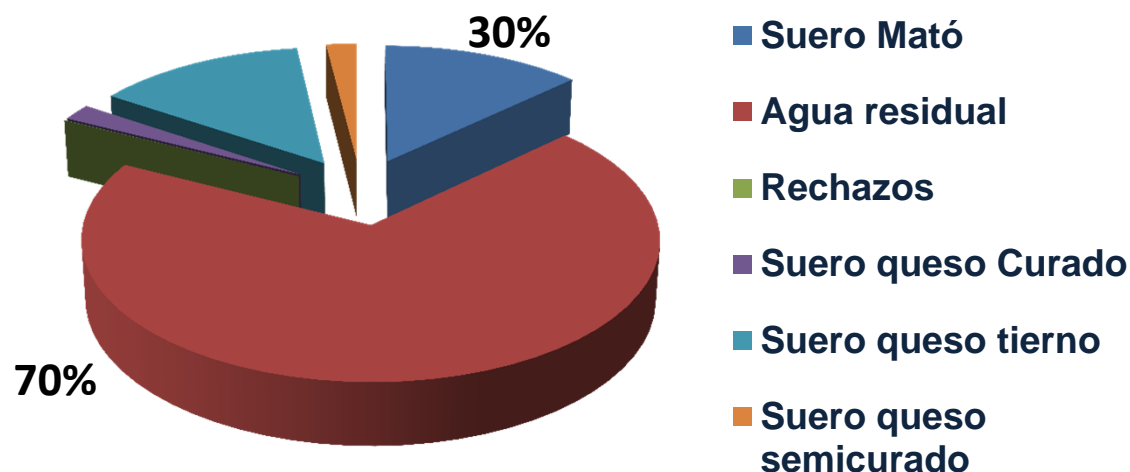

Parámetro	Efluente láctea (n = 7)
Turbidez (NTU)	$3,0 \cdot 10^3 \pm 0.6 \cdot 10^3$
DQO (mg O <sub>2</sub> /L)	$24,8 \cdot 10^3 \pm 2.2 \cdot 10^3$
COT (mg C/L)	$7,4 \cdot 10^3 \pm 0.8 \cdot 10^3$
pH	$6,2 \pm 0.4$
CE (mS/cm)	$10 \pm 1$
Total P (mg/L)	$132 \pm 13$



## 02. Proceso de electrocoagulación (EC)

### → CONDICIONES EXPERIMENTALES

- **Configuración celda electroquímica:**
  - Celda no compartimentada
  - Celda compartimentada
- **Ánodo:** Al, Fe
- **Cátodo:** Pt/Ti
- **Densidad de corriente** (condiciones amperostáticas):
  - $j = 50\text{mA/cm}^2$
  - $j = 56\text{mA/cm}^2$
  - $j = 64\text{mA/cm}^2$
  - $j = 106\text{mA/cm}^2$
- **Temperatura:** ~ 25 °C (sin control de temperatura)
- **pH:** original, ácido, básico
- **Caudal:**
  - 6L/h
  - 12L/h
  - 19L/h
  - 25L/h
  - 31L/h
  - 40L/h



## 02. Proceso de electrocoagulación (EC)

### → RESULTADOS: CELDA COMPARTIMENTADA **106mA/cm<sup>2</sup>, 40 L/h, pH original**

Rendimiento		
	99% Turbidez	99% Turbidez
	26% COT	14% COT
	33% DQO	24% DQO
	98% P	92% P
	28,5KWh/m <sup>3</sup>	35KWh/m <sup>3</sup>
	0,8 kWh/Kg DQO	1,5kWh/Kg DQO
	2,6 mg/L	0,35 mg/L
	7,3Kg/m <sup>3</sup> (17% Al)	8,9Kg/m <sup>3</sup> (21% Fe)





## 02. Proceso de electrocoagulación (EC)

### → RESULTADOS: RECUPERACIÓN DE HIDRÓGENO

106mA/cm<sup>2</sup>, 40 L/h, 2,65 Ah/L, pH original



48 L/h H<sub>2</sub> teórico

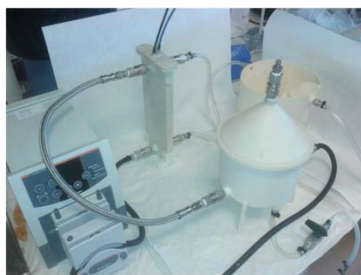

bolsas Tedlar®



Micro GC

Aluminio		
H <sub>2</sub> (% mol)	O <sub>2</sub> (% mol)	N <sub>2</sub> (%mol)
82,1	1,8	20,5

> 22 L/h GASES

H<sub>2</sub>S < 0,1%  
CO<sub>2</sub> < 0,1%  
CO < 0,1%

[Cl<sub>2</sub>] y [NH<sub>3</sub>]  
→ bajo investigación



## 02. Proceso de electrocoagulación (EC)

### → ENERGÍA TEÓRICAMENTE RECUPERADA

106mA/cm<sup>2</sup>, 40 L/h, 2,65 Ah/L



- Suponiendo 22 L/h GASES
- Ánodo: Al
- Pureza: 82% H<sub>2</sub> (mol/mol)

En condiciones normales y gases ideales: 22,4L = 1mol de gas

0,244MJ/mol H<sub>2</sub>

1KWh = 3,6MJ

**HORIZON FUEL CELLS (PEM).  
Modelo EDUSTACK PRO**

Moles de gases (mol/h)	0,98
Mol H <sub>2</sub> (mol/h)	0,81
Energía H <sub>2</sub> (MJ/h)	0,20
Energía H <sub>2</sub> (KWh)	0,05
Rendimiento pila de combustible (40%)	0,02
Energía por m <sup>3</sup> (KWh/m <sup>3</sup> )	10,93

Consumo por parte de la EC (KWh/m <sup>3</sup> )	28,50
Cantidad teórica recuperada (%)	<b>38%</b>



REWAGEN: Electrochemical WATER treatment system in the dairy industry with hydroGEN REcovery and electricity production

## Proyecto REWAGEN

**LEITAT** | Technological  
Center  
managing your technologies member of **TECNIO**  
by work, for companies

# 03 CONCLUSIONES

CONAMA2014



## 03. CONCLUSIONES

### → CONCLUSIONES

- Nuevo diseño de celda electroquímica: **binomio agua-energía**
- Potencial **escalado a planta piloto DEMO** en las **instalaciones del *end user***, en combinación secuencial con otras tecnologías.
- **Potencial transferencia de tecnología a otras Pymes, y por extensión a otros sectores.**



# GRACIAS POR SU ATENCIÓN!

## CONTACTOS:

Lara Valentin: [lvalentin@leitat.org](mailto:lvalentin@leitat.org)

Julia García: [jgarcia@leitat.org](mailto:jgarcia@leitat.org)

Carlos Pérez: [cperez@leitat.org](mailto:cperez@leitat.org)

Anna Serra Clusellas: [aserra@leitat.org](mailto:aserra@leitat.org)



## CONAMA2014